

GENERAL ELECTRIC PARTS REFERENCE GUIDE



RCA Hotpoint Kenmore JC PENNY



General Electric Parts

washer ..... 2-11  
 washer breakdowns ..... 12-17  
 dryer ..... 18-21  
 dryer breakdowns ..... 22-26  
 dishwasher ..... 27-32  
 dishwasher breakdowns .... 33-36  
 refrigeration ..... 37-45  
 range ..... 46-54

[www.appliancepartscompany.com](http://www.appliancepartscompany.com)

GENERAL ELECTRIC PARTS REFERENCE GUIDE

dishwasher . washer . dryer . range . refrigerator . microwave . dishwasher . washer . dryer . range . refrigerator . microwave



dishwasher . washer . dryer . range . refrigerator . microwave . dishwasher . washer . dryer . range . refrigerator . microwave

Part numbers and illustrations intended solely for identification. Items offered for sale not represented to be manufactured by the company that built the item.

WEST TUCSON  
520.293.8888

LAS VEGAS  
702.382.6532

RENO  
775.348.9090

SALT LAKE CITY  
801.975.1333

SAN ANTONIO  
210.223.2675

SAN ANTONIO  
210.525.0636

 <p>WH23X42 G.E. Washer Pump Assembly. 4 Port Pump. WH23X53 2 Port Pump.</p>	 <p>WH1X2026 G.E. Washer Drive Belt Fits 1968-Present.</p>  <p>WH8X305 G.E. Washer Outer Tub Gasket.</p>	 <p>WH13X81 G.E. Washer Water Valve, Prior to 95.</p>	 <p>WH1X2727 Dampening Strap, T-Line Washer Part.</p>
 <p>WH8X246 G.E. Washer Tub To Transmission Boot.</p>	 <p>WH1X1292 (Small) WH1X1580 (Large) G.E. Washer Boot Clamps. Fits WH8X246.</p>	 <p>WH1X1986 G.E. Washer Agitator Support.</p>	 <p>WH1X1944 G.E. Washer Spline WH1X2641 G.E. New Washer Style Spline.</p>
 <p>WH41X58 G.E. Washer Fill Hose 4 ft.</p>	 <p>WH8X291 G.E. Washer Transmission Top Seal.</p>	 <p>WH4X91 G.E. Washer Inner Drum Bearing Kit Used on Two Speed Clutches.</p>	 <p>WH4X102 G.E. Washer Ball Bearing, Used on Inner/Outer Drum &amp; Carrier Plate.</p>
 <p>WH49X265 G.E. Washer Two Speed Clutch Kit. (#12528 Robinair Punch Tool).</p>	 <p>WH49X231 G.E. Washer One Speed Clutch Kit.</p>	 <p>WH12X847 G.E. Clutch Shifter WH1X1797EA Spring.</p>	 <p>WH12X235* 1/3 H.P. WH12X468* 1/2 H.P. fits WH20X520 WH12X400 1/2 H.P. WH12X629 1/3 H.P. G.E. Motor Relay. * Most Common.</p>
 <p>WH49X271 G.E. Auto Washer 2 Speed Clutch &amp; Motor Assembly, c/w WH20X520 Motor, WH49X265 Clutch, WH12X847 Shifter, WH17X86 Plate.</p>	<p><b>WASHER MOTORS</b></p>  <p>WH20X520 1/2 HP. Includes WH20X52, &amp; WH12X468 Relay. Can Replace 1/3 H.P. Round or Square Motors WH20X52 1/2 HP., 1725RPM, 115V, 8.5 AMP. WH20X10002 (WH20X64) 1/3 HP., 1725RPM, 115V, 8 AMP.</p>		 <p>WH5X256 Clutch Assembly.</p>

# WASHER COMPONENTS

# G.E.



WH38X38 14lb. 14 1/4" Short Shaft  
 WH38X39 18lb. 16" Long Shaft  
 WH38X53 9 Spline, 14 1/4" Short Shaft  
 G.E. Washer Transmissions.

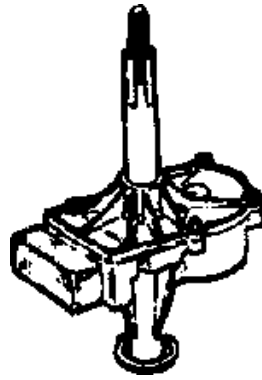

WH38X10002 (WH38X55, WH38X10001)  
 G.E. Washer New Transmission.

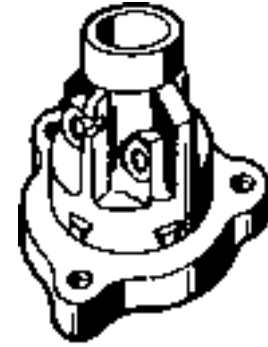

WH17X69  
 G.E. Washer Transmission Basket Hub.

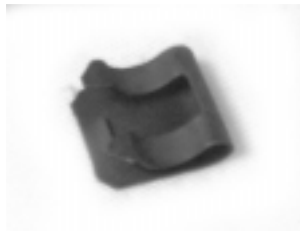

WH1X2733  
 Clip Clutch Spring, T-Line Washer Part.



WH7X58  
 G.E. Washer Spring.



WH8X281  
 G.E. Washer Transmission Lower Seal.



WH2X671EA  
 G.E. Washer Transmission Lower Cork Seal.



WH2X681EA  
 G.E. Washer Transmission Screw.

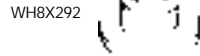

WH8X292 New Style  
 G.E. Washer Agitator Cloth Guard  
 WH8X282 Old Style.

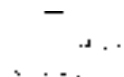

WH7X127 (WH7X45)  
 G.E. Washer Clutch Cover, Drive Plate, order Roll Pin WZ11X50 Separately.



WH40X151  
 G.E. Washer Single Speed Shaft Extension.



WZ11X50EA  
 G.E. Washer Cam Pin.



WH2X543EA  
 G.E. Washer U Bolt.  
 WH1X1169  
 G.E. Washer Clamp Plate.  
 WZ8X6EA  
 G.E. Washer Nut & Washer.



WH40X150  
 G.E. Washer Two Speed Shaft Extension.



WH1X1722  
 G.E. Washer Pump To Motor Flexible Coupler, Order WH1X1621 Clamp Separately.



WH7X110  
 G.E. Washer 2 Spd/1 Spd Clutch Shoe . Primary Clutch Shoe (Package of 2).



WH4X12  
 Ball Bearing, replacement for inner clutch drum and outer drum on most automatic washers. Models from 1950 to present.

### NOTES:

---



---



---



---



---

Part numbers and illustrations intended solely for identification. Items offered for sale not represented to be manufactured by the company that built the item.

WEST TUCSON  
 520.293.8888

LAS VEGAS  
 702.382.6532

RENO  
 775.348.9090

SALT LAKE CITY  
 801.975.1333

SAN ANTONIO  
 210.223.2675

SAN ANTONIO  
 210.525.0636

G.E.

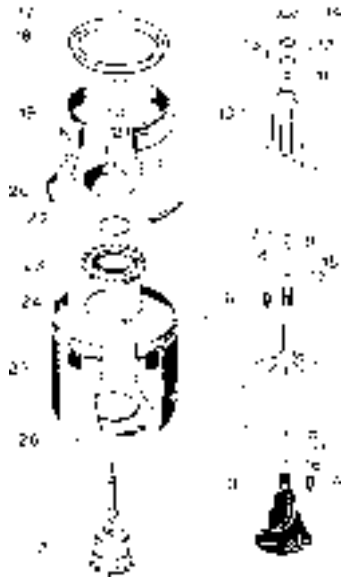

- 1A WH2X935D Screw, Clamp, 12 Pack
- 1B WH2X936D Nut, 12 Pack
- 2 Transmission
- 3 Agitator
- 4 WH1X2641 Coupling New Style
- 5 Cap, Agitator Small
- 6 WH43X99 Agitator, Hand Wash
- 7 WH2X871 Screw
- 8 Insert
- 9 WH43X95 Agitator Cap & Insert
- 10 WH43X130 Agitator
- 11 WH43X96 Slide, Locking Ring
- 12 WH43X97 Pull Ring & Insert
- 13 WH1X2273 Insert
- 14 WH47X40 Dispenser
- 15 Screw
- 16 Washer, Sealing
- 17 WH8X292 Boot, Hub
- 18 WH45X142 Ring, Filter
- 19 WH45X99, 103 Basket, Spin
- 20 WH8X305 Gasket, Tube
- 21 WH2X681D Bolt, Gasket, 12 Pack
- 22 WH1X1292 Clamp, Upper
- 23 WH8X246 Boot Mechanism
- 24 WH1X1580 Clamp
- 25 WH45X69, 116 Tube, Outer

Breakdowns and parts listed are for reference only.  
To ensure correct part, a model# is necessary.



WH43X126  
G.E. 9 Tooth Agitator, used  
With WH43X128 Cap.



WH43X105  
Agitator/Coupling Assembly, 17".



WH43X130  
G.E. Lge. Capacity Agitator, used  
With WH43X104.



WH43X87 (White)  
G.E. Spiral Fin, Short Shaft,  
White.

WH2X1147  
G.E. Agitator Stud.  
*Sorry No Image Available*



WH2X1148  
G.E. Agitator Stud for Extra Capacity.

**One Piece Uses:**  
**WH43X10009**  
**Coupling**

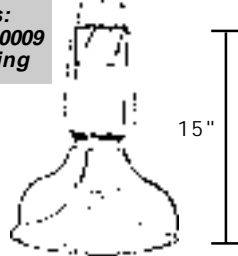

WH43X141 (White)  
G.E. New Style Agitator Single  
Action. Height 15".

**One Piece Uses:**  
**WH43X10009**  
**Coupling**

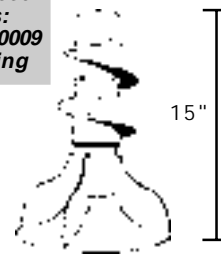

WH43X142  
G.E. New Style Agitator Dual  
Action. Height 15".

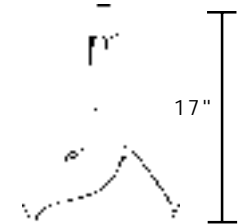

WH43X104 Almond  
WH43X99 Almond  
G.E. Large Capacity  
Height 17" Inner Agitator. Use with  
WH43X130 Agitator.

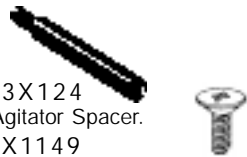

WH43X124  
G.E. Agitator Spacer.  
WH2X1149  
G.E. Agitator Spacer Screw.

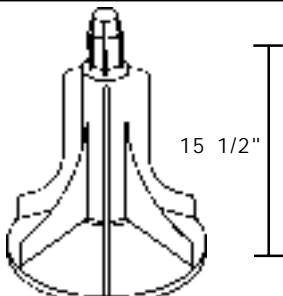

WH43X91 (White)  
G.E. Straight Fin, Short Shaft.

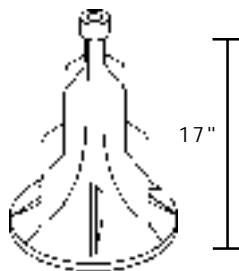

WH43X93 (Almond)  
G.E. Straight Fin, Long Shaft.  
4 Slots For Dispenser.

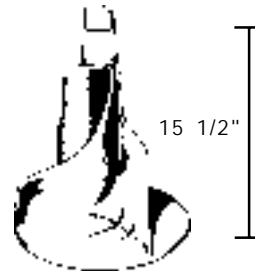

WH43X94  
G.E. New Style Agitator  
6 Slots For Dispenser.

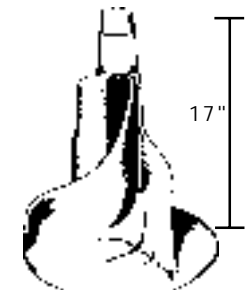

WH43X102  
G.E. Spiral Fin, Long Shaft.

Part numbers and illustrations intended solely for identification. Items offered for sale not represented to be manufactured by the company that built the item.

# WASHER







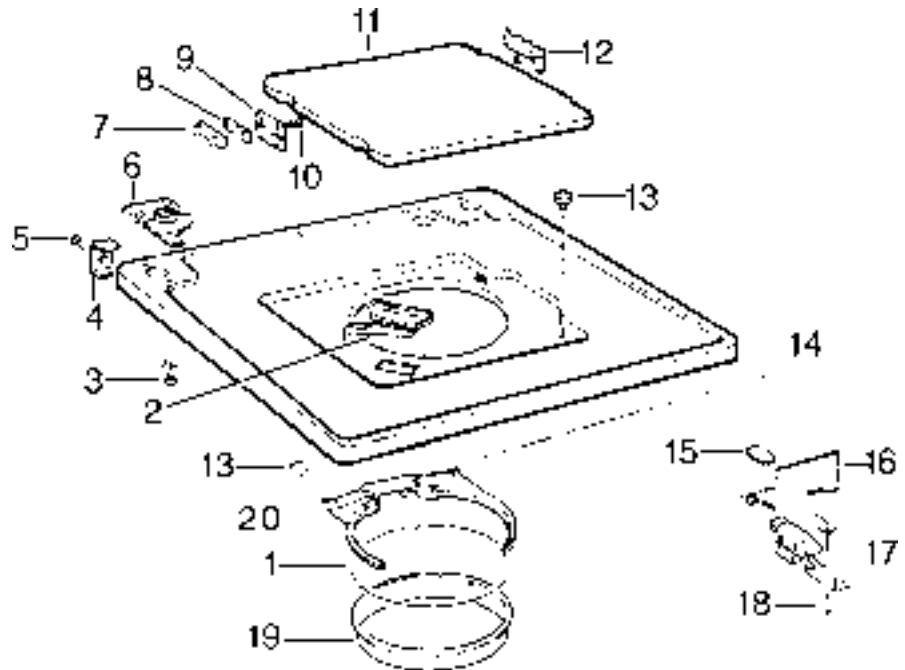



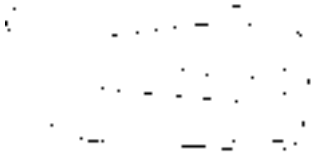

## LID ASSEMBLY

# G.E.

- 1 WH16X413 Retainer
- 2A WH1X2054 Spout, Bleach White
- 2B WH1X2232 Spout, Bleach Almond
- 3 WE2X186D Screw
- 5 - -
- 6 WE1X553 Gasket
- 7 - -
- 8 WH8X309 Gasket, Hinge
- 9 WH1X2165 Hinge
- 10 - -
- 11A WH44X1163 Lid White
- 11B WH44X1148 Lid Almond
- 12 - -
- 13A WH1X1654 Bumper
- 13B WH1X1480D Bumper
- 14A WH44X894 Cover White
- 14B WH44X980 Cover Almond
- 14C WH44X901 Cover White
- 14D WH44X984 Cover Almond
- 15 WH1X2089 Knob Actuator
- 16 WH1X2090 Actuator
- 17 WH12X494 Switch Assembly Lid
- 18 WZ4X345D Screw
- 19 WH8X366 Shield, Cover
- 20 WH16X370 Wire, Cover Shield



Breakdowns and parts listed are for reference only. To ensure correct part a model# is necessary.

 <p>WH12X494 G.E. Washer Lid Switch (Illustrated). WH12X324 Old Style Lid Switch.</p>	 <p>WH12X1044 G.E. Washer Lid Switch. WH12X1043 Lid Switch. Shorter Frame</p>	 <p>WH1X2734 G.E. Washer Lid Switch Actuator. White New Style. WH1X2785 G.E. Washer Lid Switch Actuator. Black New Style.</p>	 <p>WH1X2089 G.E. Washer Lid Switch Actuator Pad.</p>
 <p>WH8X366 With Hole G.E. Washer Cover &amp; Shield. (Illustrated) WH16X370 G.E. Washer Tub Guard Wire. WH8X295 Cover Shield.</p>	 <p>WH1X1946 G.E. Washer Cover Strap Hinge ( 2 Per Machine).</p>	 <p>WH01X10025 Bushing Hinge Front.</p>	 <p>WH1X2752 Bushing Hinge.</p>
 <p>WH1X2759 Bushing Hinge.</p>	 <p>WH1X2222 Right WH1X2085 Left Hinge Pivot.</p>	 <p>WH1X2743 Wireform Hinge, T-Line washer part.</p>	 <p>WH1X2735 Bleach Funnel.</p>

Part numbers and illustrations intended solely for identification. Items offered for sale not represented to be manufactured by the company that built the item.

WEST TUCSON  
520.293.8888



















LAS VEGAS  
702.382.6532

RENO  
775.348.9090

SALT LAKE CITY  
801.975.1333

SAN ANTONIO  
210.223.2675

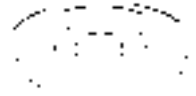
SAN ANTONIO  
210.525.0636

 <p>WH1X2086 Right WH1X2087 Left Hinge Pad.</p>	 <p>WH1X2296 G.E. Washer Friction Pad 8 Used Per Machine.</p>	 <p>WH1X1862 G.E. Washer Cushion Clamp.</p>	 <p>WH1X1654 G.E. Washer Lid Bumper. Other Common Bumpers WH1X1983EA G.E. Washer Lid Bumper. WH1X1480EA G.E. Washer Lid Bumper.</p>
 <p>WH1X1480EA 1/8 WH1X2722 1/4 G.E. Washer Lid Bumper.</p>	 <p>WH2X694D G.E. Washer Panel Screw Washer. (12 Pack).</p>	 <p>WH1X2742 Bumper Hinge, T-Line Washer Part.</p>	 <p>WH2X1001D (5303161199) G.E. Washer Tub Clip.</p>
 <p>WH1X1923EA G.E. Washer Top Clip.</p>	 <p>WH2X694D 12 PK G.E. Washer Panel Screw.</p>	 <p>WH2X1191 Locking Clip.</p>	 <p>WL1X165 G.E. Washer Large Foot Pad Peel Off Adhesive Back Secure Foot Pad To Floor.</p>
 <p>WZ7X40 G.E. Washer Jam Nut.</p>	 <p>WH1X484 G.E. Washer Foot Pad.</p>	 <p>WH2X1137 G.E. Washer Leveling Leg.</p>	 <p>WX7X1 G.E. Washer Floor Tray Catches Water Leaks/Prevents Floor Damage.</p>
 <p>WH47X40 (Almond) G.E. Washer Fabric Dispensers, A Variety Available Check Specific Model #.</p>	 <p>WH47X39 (Pre 1993) G.E. Washer Fabric Dispensers, A Variety Available, Check Specific Model #. WH47X42 Perimeter Ring 1993 and Later. WH47X43 Filter Pan 1993 and Later.</p>	 <p>WH1X2531 A- 12 1/2" WH45X141 A- 10" G.E. Washer Lint Filter. Note Agitator Head For Proper Size.</p>	

**NOTES:**

---



---



---



---



---



---

**TIMER KNOBS**



WH1X2274  
G.E. Washer Short Knob, Smooth Brown Handle. Other Common Timer Knobs, not illustrated, Check Model # For Correct Part:

WH1X2278  
G.E. Knob Plastic, 8 Tooth, 1 3/4 Diameter for Clamshell Timer. Uses WH1X2193 Hub. Uses WH1X2178 Shaft.  
WH1X2277  
G.E. Long Knob & Clip, Grated Handle.  
WH1X2721  
G.E. Knob & Clip, White  
WH1X2298  
G.E. Pull to Start Timer Knob.  
WH1X2754 New Style  
WH1X2708 New Style Chrome.  
WE1X986 Knob "U" Clip.



WH1X2721  
G.E. Washer White Rotary Switch w/Red Indicator Dot.  
WE1X1208  
G.E. Washer Almond Timer Knob with Black Stripe.

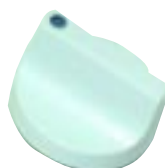

WH1X2756  
G.E. Washer White Knob GrayIndicator Dot.



WH1X2274  
G.E. Washer Chrome Timer. Smooth Brown Handle.



WH1X2299  
G.E. Washer Timer Knob Red Indicator Dot.



WH1X1942  
G.E. Washer Knob Metal, 10 Tooth, 1 1/2 Diameter Uses WH1X1941 Hub. Uses WH1X2075 Shaft.



WH1X2760 (WH1X2119)  
G.E. Washer Knob Plastic, 8 Tooth, 1 1/2 Diameter for Clamshell Timer Uses WH1X2118 Hub. WH1X2757  
G.E. Washer Knob White.



WH1X2707  
G.E. Washer Knob Almond.



WH1X92  
G.E. Washer Timer Dial, Clear. (Illustrated).

**HUBS**

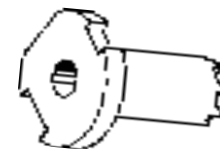

FOR CLAMSHELL TIMER  
WH1X2118 1 1/8 Plastic, 8 Tooth, Uses WH1X2760 Knob.  
WH1X2193 1 1/2 Plastic, 8 Tooth, Uses WH1X2278 Knob.  
WH1X1941 1 3/16 Metal Hub, 10 Tooth.

**DIALS**



WH11X91 Black, with Red Indicator.  
WH11X10014 Black, with White Indicator.  
WH11X118 Red Dot.  
WH11X136 Black with White Indicator.  
WH11X139 White, New Style.  
WH11X10006 Almond.

**Store Locations**

Tempe, AZ	(480) 755-0005
Peoria, AZ	(623) 972-5022
N. Phoenix	(602) 863-3476
Scottsdale, AZ	(480) 970-1010
Mesa, AZ	(480) 827-0161
S. Tucson, AZ	(520) 624-2102
E. Tucson, AZ	(520) 751-8800
N.W. Tucson, AZ	(520) 293-8888
Las Vegas, NV	(702) 382-6532
Reno, NV	(775) 348-9090
Salt Lake City, UT	(801) 975-1333
San Antonio, TX	(210) 223-2675
San Antonio, TX	(210) 525-0636

[www.appliancepartscompany.com](http://www.appliancepartscompany.com)

## NEW COMPLETE TIMER ASSEMBLIES FOR G.E./HOTPOINT/RCA

G.E. part #	Timer #	G.E. part #	Timer #	G.E. part #	Timer #
WH12X640	905C99G006	WH12X930	905C969G044	WH12X1017	175D2307P023
WH12X900	175D1432G002	WH12X931	905C969G045	WH12X1021	175D2307P006
	175D1432G009	WH12X932	905C969G046	WH12X1022	175D2307P004
WH12X901	175D1432G003	WH12X933	905C969G047	WH12X1024	175D2307P005
WH12X903	175D1432G005	WH12X935	905C969G051	WH12X1026	175D2307P056
WH12X904	175D1432G006	WH12X961	175D143G019	WH12X1030	175D2307P024
WH12X905	175D1432G007	WH12X966	175D1432G022	WH12X1034	175D2307P007
WH12X906	175D1432G008	WH12X988	905C969G063	COMMERCIAL	
WH12X929	905C969G043	WH12X1000	175D2307P013	WH12X702	964D129G005
		WH12X1015	175D2307P046	WH12X1052	175D2691P002

## MODEL CROSS REFERENCE TIMER ASSEMBLIES FOR G.E./HOTPOINT/RCA

G.E.	HOTPOINT	RCA	G.E. PART#
WWA8350PER			WH12X602
WWA660RBLWH			WH12X904
WLW3700RBL			WH12X905
WLW5304VNL WWA5304VPL WWA5411BAL WWA5411GAL WWA5412BAL WWA5412GAL WWA5600BAL WWA5600GAL WWA5600GBL WWA5636MAL WWA5669MAL WWA5800BAL WWA5800GAL WWA5800GBL WWA5800MAL WWA5826MAL WWA6600MAL WWA8072BAL WWA8072GAL WWA8300BAL WWA8300GAL WWA8300GBL WWA8301MAL WWA8306LAL WWA8306LBL	WLW1500BAL WLW1500BBL WLW1500BCL WLW1500NBL WLW3310BBL WLW3300BCL WLW3310BNL	WRW3305KBL WRW3305MAL WRW1505KAL WRW1505KBL WRW1505MAL WRW3305KAL WLW3310BNL	WH12X929
WWA7050BAL WWA7050GAL WWA7050GBL WWA7070BAL WWA7070GAL WWA7070GBL WWA7800MAL WWA7826MAL WWT2450GAV WWT2470GAV	WLW2500BAL WLW2500BBL WLW2500BCL WLW2500BNL WLW3500BAL WLW3500BBL WLW3500BCL WLW3500BNL WLW3700BAL WLW3700BBL WLW3700BCL WLW3700BNL WLW3750BAL WLW3750BBL WLW3750BNL	WRW2505KAL WRW2505KBL WRW2505MAL WRW3505KAL WRW3505KBL WRW3505MAL WRW3705KAL WRW3705KBL WRW3705MAL	WH12X930

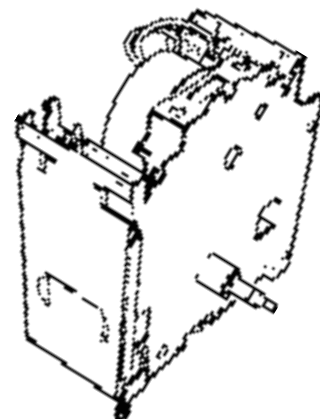
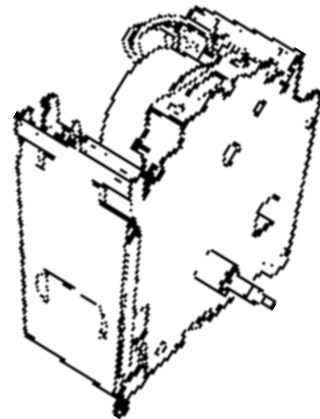

# WASHER TIMERS

# G.E.

G.E.	HOTPOINT	RCA	G.E. PART#
WWA7619MAL WWA8318LAL WWA8318LBL WWA8320BAL WWA8320GAL WWA8320GBL WWA8330BAL WWA8330GAL WWA8330GBL WWA8340BAL WWA8340GAL WWA8340GBL WWA8340MAL			WH12X931
WWA7646MAL WWA7678MAL WWA8350BAL WWA8350GAL WWA8350GBL WWA8354VLL WWA8354VML WWA8354VNL WWA8500GAL WWA8500GBL WWA8500GCL WWA8806MAL WWA8808MAL WWA9800MAL			WH12X932
WWA8360BAL WWA8360GAL WWA8360GBL WWA8366LAL WWA8366LBL WWA8480BAL WWA8480GAL WWA8600GAL WWA8600GBL WWA8600GCL WWA8700LAL WWA8700LBL WWA8869MAL WWA8887MAL WWA9850MAL WWA9890MAL	WLW5700BAL WLW5700BBL WLW5700BCL WLW5700BNL WLW5900MAL WLW5900MNL	WRW5705KAL WRW5705KBL WRW5705MAL	WH12X933
WWA6407LBL WWA7010GAL WWA7010GBL WWA8307LAL WWA8307LBL WWA8310GAL WWA8310GBL WWA8324GAL WWA8324GBL WWA8326LAL WWA8326LBL	WLW2330BAL WLW3300BBL WLW3300BCL		WH12X935
WWA7619MAL			WH12X931
WPSQ4160T			WH12X1037
WPXQ3120T			WH12X1034
WPXQ3090T	VVXR4100T WWSR3080T		WH12X1021
WDSR4110T WJSR2080T WJXR2080T			WH12X1022

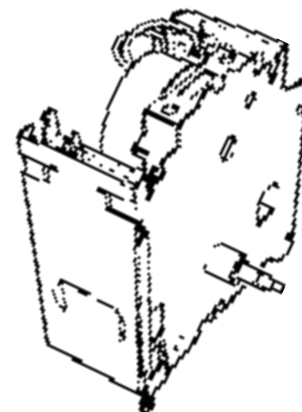
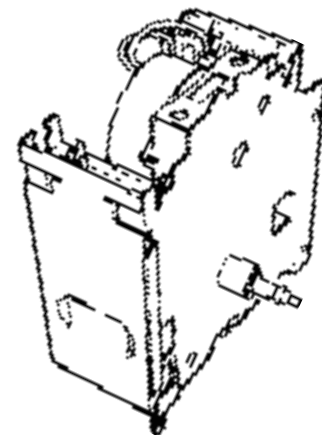

G.E.

Part numbers and illustrations intended solely for identification. Items offered for sale not represented to be manufactured by the company that built the item.

WEST TUCSON  
520.293.8888

LAS VEGAS  
702.382.6532

RENO  
775.348.9090

SALT LAKE CITY  
801.975.1333

SAN ANTONIO  
210.223.2675

SAN ANTONIO  
210.525.0636

G.E.	HOTPOINT	RCA	G.E. PART#		
WBSR1060T			WH12X1030		 WH12X633 G.E. Timer Motor.
WCSR2070T		YJSR2070T	WH12X1031		
WBXR1060T WCXR1070T	VBXR1060T	YBXR1060T	WH12X1000		
	VBXR2070T	YBXR2070T VVXR1040T	WH12X1015 WH12X1017		
 WH12X644 Timer Motor.	 WH12X855 Pressure Switch.	 WH12X10065 Pressure Switch.	 WH12X10068 G.E. Pressure Switch.		
 WH12X738 Water Temperature Switch.	 WH12X999 Rotary Switch.	 WH12X1007 G.E. Rotary Switch.	 WH12X1019 Rotary Temperature Switch.		
 WH12X1025 Rotary Switch.	 WH42X1062 Clothes Retainer, white plastic.	 WH2X650 Compression Ring, T-Line washer part.	 WH2X1193 Hub Nut.		
 WH1X2728 Self Cleaning Filter.	 WH1X2117 Spring Clip, T-line washer part.	 WH41X10037 G.E. Washer Water Inlet Spout.	 WH41X374 G.E. Washer Pump Outlet Hose.		
 WH41X371 G.E. Washer Tub To Pump Hose. Accordian Style.	 WH41X132 G.E. Washer Water Inlet Spout.	 WH41X99 G.E. Washer Water Spout To Tub Hose.	 WH41X170 G.E. Washer Water Spout To Tub Hose.		

