

WB44X5099
G.E./Hotpoint
Standard Bake Element.

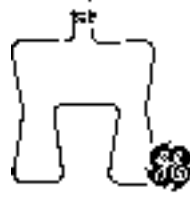

WB44X5082
G.E./Hotpoint
Self Clean Bake Element.



WB44X5043
G.E./Hotpoint Standard
Narrow Bake Element.



WB44X200
G.E./Hotpoint Self Clean
Narrow Bake Element.

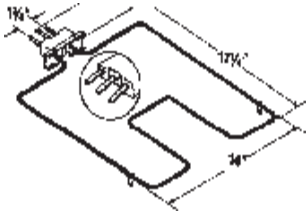

WB44X142 (RP44X142)
G.E./Hotpoint Small Oven
Bake Element.



WB44X196
G.E./Hotpoint Small Oven
Bake Element.



WB44K5012 (WB44M1)
Roper Bake Element. Fits
Some Kenmore Brands.



WB44X169
G.E./Hotpoint Element.

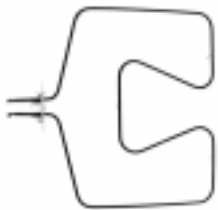

WB44X164
G.E. Bake Element, hinged,
18" X 15-3/4", 3000W, 240V.

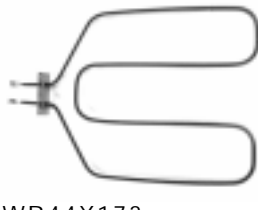

WB44X173
G.E. Broil Element, fixed,
12-1/2" X 15-5/8", 3410W,
240V.

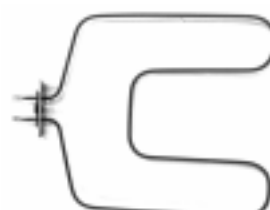

WB44X190
G.E. Bake Element, hinged,
13-1/2" X 16", 2585W, 240V.

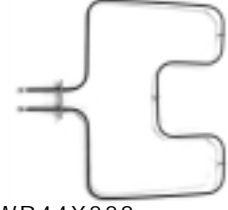

WB44X228
G.E. Bake Element, fixed,
18-1/4" X 15-1/2", 3000W,
240V.

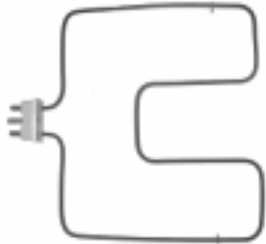

WB44X5019
G.E. Bake Element, fixed/
ceramic, 15-1/2" X 15",
3000W, 240V.



WB44X5045
G.E. Broil Element, hinged,
12-1/2" X 16", 3300W, 240V.

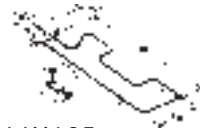

WB44X195
G.E./Hotpoint Upper Oven
Style Bake Element.



WB44X139
G.E./Hotpoint Upper Oven
Style Broil Element.

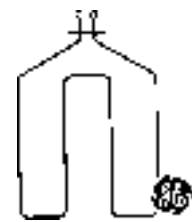

WB44X134
G.E./Hotpoint Broil Element.
WB44X185
Self Cleaning.



WB2X1452
G.E./Hotpoint Broil Element
Hanger.





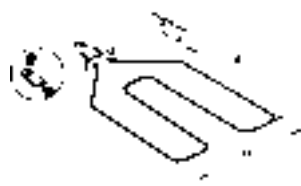





WB2X9719
G.E. Broil Support.



WB44X5074
G.E./Hotpoint Broil Element
(Self Clean).



WB44X136
G.E./Hotpoint Upper Oven Broil
Element.

SURFACE ELEMENTS			
 <p>WB30X218 6" WB30X219 8" G.E./Hotpoint Plug In Element uses WB17X5051 Receptacle.</p>	 <p>WB30M1 G.E./Hotpoint New 6" Plug In Element. WB30M2 New 8" Plug In Element uses WB17X5113 Receptacle.</p>	 <p>WB30X359 G.E./Hotpoint 6" Hinged 2 Wire In Element. WB30X348 8" Hinged 2 Wire In Element c/w Block.</p>	 <p>WB30X356 G.E./Hotpoint 6" 3 Wire In Element c/w Ring. WB30X354 8" 3 Wire In Element c/w Ring.</p>
 <p>WB30X342 G.E./Hotpoint 6" 3 Wire Hi Rise Element. WB30X341 8" 3 Wire Hi Rise Element.</p>	 <p>WB30X346 G.E./Hotpoint 8" 4 Wire Element. WB30X357 8" 4 Wire Element, uses Sensor.</p>	 <p>WB30X256 G.E./Hotpoint New 6" Plug In Element (4 Turn). WB30X255 New 8" Plug In Element (5 Turn) uses WB17X210 Receptacle.</p>	 <p>WB30X254 G.E./Hotpoint New 6" Plug In Element (3 Turn). WB30X253 New 8" Plug In Element (4 Turn) uses WB17X210 Receptacle.</p>

RANGES

SERIES	DESCRIPTION	SERIES	DESCRIPTION
WB1	SCREWS, BOLTS NUTS & WASHERS	WB26	MOTORS
WB2	MISCELLANEOUS - SMALL PARTS	WB27	ELECTRONIC OVEN COMPONENTS
WB3	SW. BUTTONS & CONTROL KNOBS	WB28	COOLER UNITS & COLTS
WB4	NAMEPLATES & ESCUTCHEONS	WB30	SURFACE UNITS
WB5	OVEN UNIT CONTACT SPRINGS	WB31	SURFACE UNIT RINGS
	INSULATORS, CLIPS & SPACERS	WB32	SURFACE UNIT PANS & CENTER TRIM
WB6	MISCELLANEOUS SMALL PARTS	WB36	LAMP SHADES, PARTS & ASM
WB7	TRIM & TRIM PLATES	WB38	VENTS, ASSEMBLIES & PARTS
WB8	RECEPTACLES	WB39	GUIDES _ DRAWERS TRAYS ETC
WB9	SPRINGS	WB44	OVEN UNITS
WB10	HINGE BEARINGS SUPPORTS & CATCHES	WB45	OVEN UNIT COLTS & ASM
WB11	ROTORS (TIMER)	WB48	SHELVES & RACKS
WB12	COILS (TIMER)	WB49	TRAYS PANS, GRIDDLES, BAFFLES
WB14	HINGES & STRIKES	WB50	COOKER PALLS LIDS & ASM
WB15	HANDLES	WB51	PRESSURE COOKER LIDS & ASSY..
WB17	TERMINALS & TERM. BLOCKS	WB53	OVEN LINERS
WB18	LEADS & LEAD WIRE	WB55	DOORS LINERS & ASM.
WB19	TIMERS	WB58	DRAWERS LESS PANELS
WB20	TRANSFORMER & TEMPERATURE CONTROL ASM. & PARTS	WB59	TERMINAL COVERS
WB21	TEMPERATURE CONTROLS	WB60	USER BOOKS
WB22	SWITCHES _ OVEN	WB61	BACKSPLASHERS & ASSEMBLIES
WB23	SWITCHES - SURFACE UNITS	WB62	COOKING TOPS
WB24	SWITCHES - MISCELLANEOUS	WB63	BODY ASSEMBLIES & PARTS
WB25	SWITCH INDICATORS	WB64	ACCESSORY PACKAGES

Part numbers and illustrations intended solely for identification. Items offered for sale not represented to be manufactured by the company that built the item.

WEST TUCSON
520.293.8888

LAS VEGAS
702.382.6532

RENO
775.348.9090

SALT LAKE CITY
801.975.1333

SAN ANTONIO
210.223.2675

SAN ANTONIO
210.525.0636



WB17X210
G.E. Receptacle Assembly
and Terminal Block - Plastic.

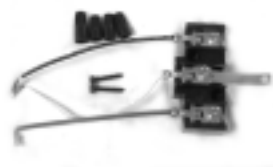

WB17X5095
G.E. Receptacle Assembly
and Terminal Block.



WB17X5051
G.E./Hotpoint Ceramic
Receptacle. For Original G.E.
Style Plug-in Burners.



WB17X5113
G.E./Hotpoint Plastic
Receptacle. Fits Regular Style
Burners.



WB5X5002
G.E./Hotpoint Terminal.



WB17X105
G.E./Hotpoint Contact Block.
WB2X574EA
G.E./Hotpoint Clips for Blocks.

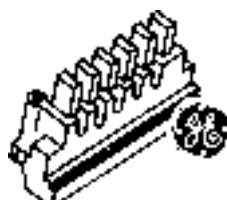

WB23X33
G.E./Hotpoint Push Button
Switch.



WB23X5102 (WB23X40)
G.E./Hotpoint Push Button
Switch 1" Stems.



WB21X5243
G.E./Hotpoint Push to Turn
Switch Kit. 1 5/8" Break Off
Shaft. (5500-212).



WB23X5070
G.E./Hotpoint
Switch for 3 Wire Burner
CW, 1/2" D-Stem Shaft.



WB21X5237
G.E. Infinite Heat Switch,
Push to turn, 3/4" Shaft.



WB21X5246
G.E. Infinite Heat Switch,
Push to turn, 1" Break off
Shaft.



WB23K5027
G.E. Element Control,
Push to turn, 3/4" Shaft.



WB23M24
G.E. Element Control, 1500W,
Push to turn, 3/4" Shaft.

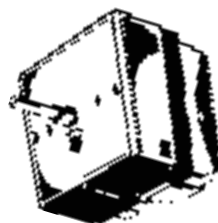

WB21X184
G.E./Hotpoint Responder
Switch Use with sensor
WB21X5207.



WB21X5207
G.E./Hotpoint
Surface Unit Sensor Yellow.
WB21X5054
G.E./Hotpoint Surface Unit Sensor White.



WB21X162
G.E. Responder.



WB2X7909
G.E. Anti-Tip Kit.

THERMOSTATS

THESE 3 THERMOSTATS REPLACES MOST G.E. & HOTPOINT RANGES. USE MODEL # TO VERIFY OR TO REFERENCE OTHER THERMOSTATS

- WB21X5208
G.E./Hotpoint Thermostat 34" Cap.
261D957G29
- WB21X5209
G.E./Hotpoint Thermostat 62" Cap.
261D957G30
- WB21X5212
Hotpoint Thermostat 34" Cap.
261D957G28
2 Amp, 120 - 240V.

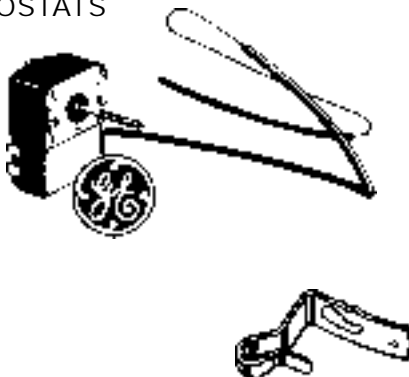

WB2X6957
Thermostat Insallation Kit.

WB2X5041EA
Thermostat Bulb Clip.

THERMOSTATS - SELF

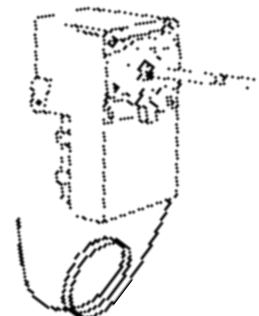

WB24X176 (262D955G010E)
G.E./Hotpoint Thermostat 48" Cap.
WB21X5320 (WB24X184)
G.E./Hotpoint Thermostat 72" Cap.



WB21X158 2 7/8" Long Probe
G.E./Hotpoint Self Cleaning Oven Sensor.
Resistance 16Ω, Increases with Temp.
Complete with Ceramic Nuts. (Illustrated)

WB21X5301 6" Long Probe
G.E./Hotpoint Self Cleaning Oven Sensor.
1000Ω Plug in Block Connection.

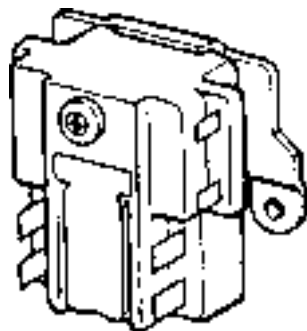

WB21X180 (405C334G001)
G.E./Hotpoint Hot Wire Relay For Self
Cleaning Oven.

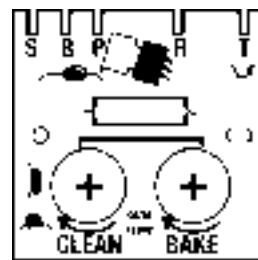

WB24X162
G.E./Hotpoint Terminal Board
For Self Cleaning Oven.

SWITCH KITS

4 POSITION BAKE/BROIL

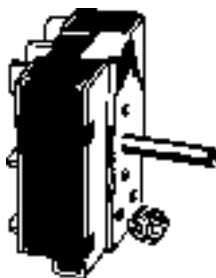

WB22X5132 (ASR4167-144)
G.E./Hotpoint Time Bake and Browning.
WB22X5134 (ASR4167-261)
Time Bake.
WB22X5136 (ASR4167-263)
Standard Selector Switch.

BAKE/BROIL

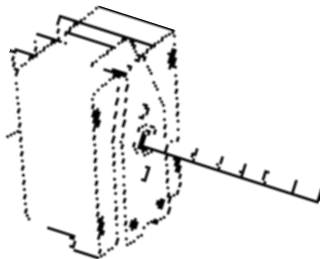

WB22X5131 (ASR4167-143)
G.E./Hotpoint Time Bake and Browning.
Come With Wires.
WB22X5133
Time Bake.
WB22X5135 (ASR4167-262)
Standard Selector Switch.
Comes with Wire.

**5 POSITION SELF CLEAN
SWITCHES OFF-BAKE-TIME
BAKE-CLEAN-BROIL**

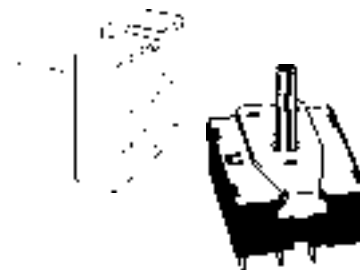

WB22X53
G.E./Hotpoint 5 Position Selector Switches
ASR5177-12.
WB22X5123 (ASR5177-219)
WB22X5122
WB22X5130 (ASR5177-210)

Part numbers and illustrations intended solely for identification. Items offered for sale not represented to be manufactured by the company that built the item.



WB20K2
G.E. Thermostat, 44" Cap Length.



WB20K5
G.E. Thermostat, 42" Cap Length.



WB20K8
G.E. Thermostat, 43" Cap Length.



WB21X489
G.E. Thermostat, 47" Cap Length.



WB21X5210
G.E. Thermostat Package, 45" Cap Length.



WB21X5287
G.E. Thermostat, 35" Cap Length.

**GUARANTEED
PARTS
PRICE
SERVICE**

13 LOCATIONS TO SERVE YOU!

Tempe . Peoria . North Phoenix
Mesa . Scottsdale . South Tucson
North Tucson . East Tucson . Las Vegas . Reno
Salt Lake City . San Antonio (2 locations)

North Phoenix
1536 West Bell Road
Phoenix, AZ, 85023
(602) 863-3476

Scottsdale
2200 North Scottsdale Road
Scottsdale, AZ, 85257
(480) 970-1010

South Tucson
1525 South 4th Avenue
Tucson, AZ, 85713
(520) 624-2102

Reno
3000 Mill St
Reno, NV, 89502
(775) 348-7733

San Antonio
1232 N. Hackberry.
San Antonio, Texas, 78202
(210) 223-2675

Peoria / Arrowhead
8581 W Kelton Lane
Phoenix, AZ, 85382
(623) 972-5022

Tempe
6825 South Kyrene Rd.
Tempe, AZ, 85283
(480) 755-0006

North West Tucson
3656 North Oracle Road
Tucson, AZ, 85705
(520) 293-8888

Salt Lake City
2181 North California Ave.
Salt Lake City, Utah, 84101
(801) 975-1333

San Antonio
2577 Jackson Keller RD.
San Antonio, Texas, 78230
(210) 525-0636

Mesa
255 East-Southern Ave.
Mesa, AZ, 85210
(480) 827-0161

East Tucson
7155 East Broadway
Tucson, AZ, 85710
(520) 751-8800

Las Vegas
2001 Western Ave
Las Vegas, NV, 89102
(702) 382-6532

Join us on-line
www.appliancepartscompany.com

RANGE
DRIP BOWLS

G.E.



Chrome
WB31X5010
6" Pan & Ring.
WB31X5011
8" Pan & Ring.

Black
WB32X5070
6" Pan & Ring.
WB32X5069
8" Pan & Ring.



Chrome Pans
WB32X5045
6" Pan.
WB32X5036
8" Pan.



Aluminum Pans
WB32X10012 (WB32X36)
6" Pan.
WB32X10013 (WB32X34)
8" Pan.



Gray Porcelain Pans
WB32X5077
6" Pan.
WB32X5061
8" Pan.



Chrome Rings
6" Ring
WB31X5013
WB31X50 Used On WB30X356.
8" Ring
WB31X5014
WB31X49 Used On WB30X354.



WB32K5041
6" Burner Bowl.
WB32K5042
8" Burner Bowl.
used in: JDP37GVH.



WB32X107
6" Burner Bowl.
WB32X106
8" Burner Bowl.
Single Flat Slot. Used in: JCP67V,
JCS57V, JAS02V.



WB31M16
6" Burner Bowl.
WB31M15
8" Pan & Ring Bowl
Single Notch, Chrome. Used in:
JSS26GV, JSS16PW, JMS08GV,
JP626WV, JP326WV, JMS08GV,
JSP31WV, JP626AV, JP326CV.



WB31M1
6" Burner Bowl.
WB32X106
8" Pan & Ring Bowl
Single Flat Slot. Used in: JDP39WV,
JDP36GV, JDS26GV, JP201CV, JP200V,
JBS04.



Black Porcelain
WB31M20
6" Pan & Ring Bowl.
WB31M19
8" Pan & Ring Bowl
Single Raised Slot. Can be used for Chr.
WB31X5010, WB31X5011
used in: JSP34AV, JSP28GV,
JMP28GV, JP326BV, JBP47GV,
JBP45AV, JSP26GV, JBP26GV,
JBP26AV.



WB32X5075
6" Burner Bowl.
WB32X5076
8" Pan & Ring Bowl
Single Raised Slot. Used in: JBP46GV,
JBP26WV, JBP25GV, JBP24GW, JBP21GV,
JBP19GV, JBS03V, JBS27WV, JBC27GW,
JBS27GV, JBS26WV, JBS07V, JBS03GV,
JBS27AV.



Gray Porcelain
WB32X5059
6" Pan & Ring Bowl.
WB32X5060
8" Pan & Ring Bowl
used in: JBP45WV, JBP46GV.



Black Porcelain
WB32X5069
8" Flat Pan & Ring Bowl.
WB32X5070
6" Pan & Ring Bowl.

Part numbers and illustrations intended solely for identification. Items offered for sale not represented to be manufactured by the company that built the item.

WEST TUCSON
520.293.8888

LAS VEGAS
702.382.6532

RENO
775.348.9090

SALT LAKE CITY
801.975.1333

SAN ANTONIO
210.223.2675

SAN ANTONIO
210.525.0636

G.E.



WB14X5035
G.E./Hotpoint Latch Mechanism.
WB14X5036
G.E./Hotpoint Latch (Heavy Spring).

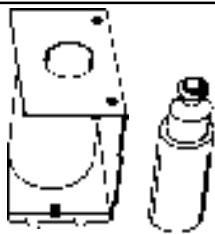

WB24X5096
G.E./Hotpoint Solenoid & Armature, c/w Mounting Bracket. Replaces WB24X197
WB24X5097
G.E./Hotpoint Solenoid & Armature Only.



WB2X2030
G.E./Hotpoint Latch Clip.



WB3X5667
WB3X434 (NLA)
G.E./Hotpoint Latch Knob.



WB25X65
G.E./Hotpoint Red Jewel.

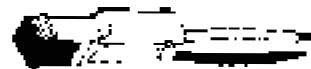

WB2X1608
G.E./Hotpoint 118 V Indicator Light.
WB2X3468
236 V Neon Light.

OVEN RUBBER GASKETS



WB2X1522 66" Long.
WB2X2058 44" Long.
WB2X5103 45" Long.
G.E./Hotpoint

SELF CLEANING OVEN GASKETS



SILVER GASKETS
WB2X3138
G.E./Hotpoint 67" Long.
WB2X6547
73" Long.

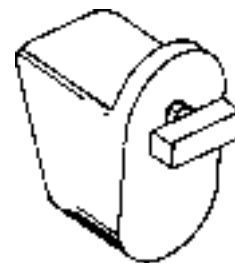

WB2X4511
G.E./Hotpoint Self Support.

DOOR GASKETS

Other Common G.E. Gaskets

WB2X6207
WB2X2257
WB2X5052
WB2X5084
WB2X6379
WB2X6700
LARGE GASKET
WB2X5192
WB2X3048



CLOCK KNOB

WB3X459
Chrome knob pkg. of 3.
WB3X5699
Black knob pkg of 3.
Other Styles
WB3X321
Chrome knob.
WB3K5065
Clock knob.
WB3X5630
Black clock knob.

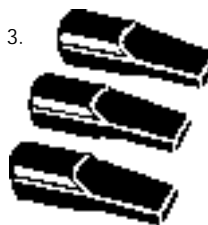

WB15X5189
G.E. Handle End Cap Kit.

RANGE KNOBS



WB3X459



WB3X5636



WB3K60

RANGE KNOBS

WB3K60	Thermostat Knob	1/4" "D" Shaft
WB3X439	Surface Unit Knob	3/16" "D" Shaft, flat left
WB3X459	Timer Knob, 3 Pk.	Chrome, split shaft
WB3X464	Surface Unit Knob	3/16" "D" w/flat left at off
WB3X712	Surface Unit Knob, gas	3/8" "D" Shaft, flat down, "Lite" before HI
WB3X714	Surface Unit Knob, gas	3/8" "D" Shaft, flat down, "Lite" after HI
WB3X716	Thermostat Knob	3/8" "D" Shaft, flat down
WB3X5479	Surface Unit Knob-ribbed, gas	1/4" Dimple up shaft
WB3X5636	Surface Unit Knob	3/16" "D", flat left
WB3X5699	Timer Knob, 3 Pk.	Split Shaft

RACKS

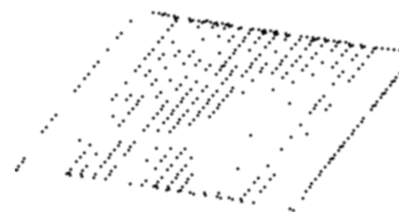

G.E. OVEN RACKS
WB48X5044
16" X 22 3/4.
WB48X5012
17 1/4" X 22 3/4.
Please Call Us With Model Number of Appliance When Ordering Oven Racks

RANGE HOOD FILTERS



WB2X2052
Domed Aluminum Mesh



WB2X4263
Flat Aluminum Rectangular
7 1/4" x 9 1/2"



WB2X6731
3 1/2" x 14 1/2"



WB2X7692
Charcoal Filter
WB2X2266
Charcoal Filter
17" x 11 3/8"

WB2X8406
Charcoal Filter (With Indicator)
10 1/2" x 9"

WB2X9761
Charcoal Filter (With Indicator)
11 1/2" x 10 1/2"

WB2X9883
Microwave Filter
18" x 6". Used On JX81 Series
Models.

WB2X3022
Charcoal-Felt Filter
26 1/2" x 13"

WB2X6731
Grease Filter
14 1/2" x 3 1/2"

WB2X9760
3/8" Charcoal Rectangular
10 3/8 x 11 3/8"

WB2X2891
Charcoal Filter
11 1/2 x 10 3/8
Used on JN310*02 Model.

WB2X2892
Charcoal Filter
11 3/8" x 17"
Used on JN334, JN634 Model.

WB2X2893
Grease Filter
11 1/4" x 10 3/8"
Used on JN332 Model.

WB2X4891
10 1/4" x 11 1/2"
WB2X4267
Microwave Filter, Used on JX81
Series Models

WB2X1559
7.40" x 6.48"
WB2X1666
12 3/4" x 4 3/4"

WB2X2158
17" x 11 1/2"
WB2X2189
13 1/4" x 10"



WB32X89
WB32X95
G.E./Hotpoint Gas
Grate.



WB32X84
G.E./Hotpoint Gas Pan.



WB32X90
G.E./Hotpoint Gas Pan.

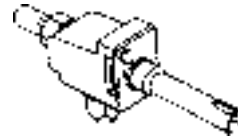

WB21X467
G.E./Hotpoint Top
Burner Valve Flat Down.

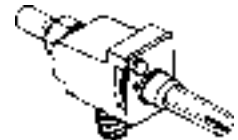

WB21X5235
G.E./Hotpoint Top
Burner Valve 1/8" Flat
Up.



WB19K12
G.E. Safety valve
assembly, 3/8" inlet,
12" Cap., 1/2" PSI.



WB19K13
G.E. Safety valve
assembly, 3/8" inlet,
bi-metal, 1/2" PSI.



WB19K14
G.E. Valve Control,
3/8" Horz. inlet,
bi-metal, 1/2" PSI.



WB21X422
G.E. Burn Valve
1/8" pipethread, Horz.
"D" Shaft.



WB2X10016
G.E./Hotpoint Ignitor.
Fits many brands.

Part numbers and illustrations intended solely for identification. Items offered for sale not represented to be manufactured by the company that built the item.

WEST TUCSON
520.293.8888

LAS VEGAS
702.382.6532

RENO
775.348.9090

SALT LAKE CITY
801.975.1333

SAN ANTONIO
210.223.2675

SAN ANTONIO
210.525.0636

