



66128-1
Admiral Defrost Timer
6hr 21min.



68233-1 6hr 21min.
68233-2 8hr 21min.
68233-3 10hr 21min.

Common MAYTAG/Admiral

DEFROST ELEMENTS

- 60106-34 17 7/8" 400W, Top Mount
- 60106-35 20 1/2" 450W
- 60106-36 21" 500W, Top Mount
- 12000029 21" 500W includes 52085-28
- 61001846 (2) 9 1/2" for Side x Side - Short
- 61001874 (61001140) (2) 11 1/2" for Side x Side - Long
- 12001028 20-1/4" on 19 cu. ft. model w/T-Stat
- 12000029 22" comes with T-Stat
- 52763-9 23-3/4" 500W

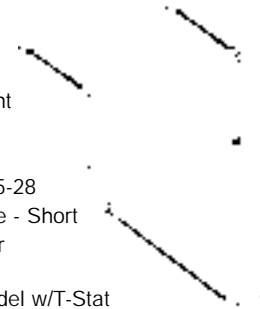

52085-29
Admiral Defrost Thermostat
Opens 40. Disconnect Ends.



52085-19
Admiral Defrost Thermostat
Opens 80. Male + Female Ends.
52085-17
Admiral Defrost Thermostat
Opens 80. Male Bullets.

ADMIRAL DEFROST THERMOSTAT

- 52085-29 Opens 40. Female Ends.
- 52085-28 Opens 47. Male Ends.

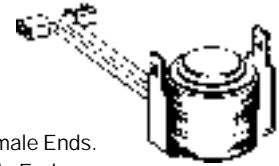

52085-9
Admiral Defrost Thermostat
Opens 40.

Common MAYTAG/Admiral

COLD CONTROLS

	Cut In	Cut Out	Cap Length
68119-1	33	23	30"
68601-3	(Use: 68601-6)		
68601-6	37	27	29"
52881-51	-	-	-
12000034	30.5	17.5	9"
12000036	32.5	19.5	16"
126100282	-	-	-
65268-2	30.5	17.5	9"



61003421
Admiral Switch Board. For water and ice in door.

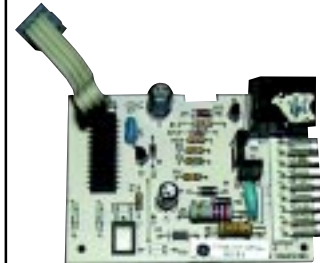

61003425
Admiral Control Board. For water and ice in door.



61005629 (61004870)
Admiral Control Assembly.

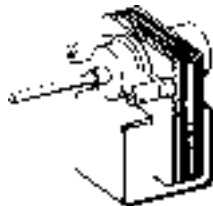



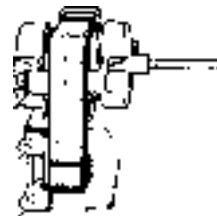



56488-2
Admiral Evap. Motor
CW 5/8 x 1 3/8". Replaces
55394-7, 56488-4.



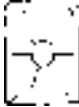
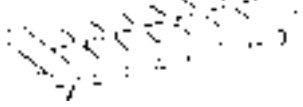



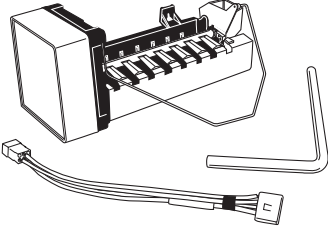
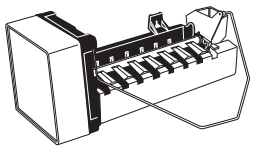

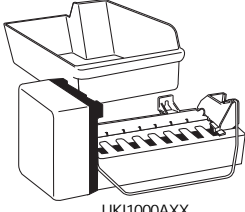
54482-10
Admiral Evap. Motor
CCW 3/16".

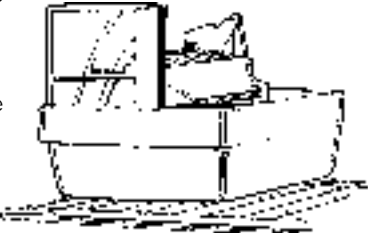

<p>59688-1 Admiral 24 Cube Flex Tray.</p>  <p>58706-1 Metal Clip.</p>  <p>65318-1 Plastic Clip.</p> 	 <p>59281-2 Maytag Ice Cube Tray. 61002140 Maytag Small Cube Ice Tray.</p>	<p>MAYTAG/Admiral ICE MAKERS</p> <p>RA43714-9 Cycles Every 154 Minutes, Plug. RA43714-8 Cycles Every 79 Minutes. RA43714-10 Cycles Every 33 Minutes. RA95019-1 Icemaker Head Upgrade Kit Side x Side. RA95020-1 Icemaker Head Upgrade Kit Top Mount.</p> <p>All the above are NLA - Use: MHIK7989 Retro Fit Icemaker for Twist Tray. 12001302 Installation Kit. Will not dispense through door.</p> 
---	---	---

 <p>UNVIM98 Admiral Icemaker.</p>	 <p>61005508 (68972-4) Admiral Icemaker.</p>	 <p>UKI1500AXX Kit Top Mounts 97 - later UKI2500AXX Kit Side by Side 97 - later UKI1000AXX (Use: UKI1500AXX) Icemaker Kit</p>	 <p>UKI1000AXX Admiral Complete Add-On Icemaker Kit. 16001882 Admiral Icemaker Cord.</p>
--	---	---	---

<p>12500009 For a Top Mount Model built Prior to 1985. 12500010 For a Side x Side Prior to 1985. 12500011 For a Top Mount Model 1985-90. 12500012 For a Side x Side Model 1985-90.</p>  <p>12500048 New Heat Release Icemaker. 68972-4 (626640) New Heat Release for Bare Icemaker.</p>	<p>MAYTAG/Admiral WATER VALVES</p>    <p>12001415 Single Valve. 55996-5 Icemaker Valve. 12001414 Icemaker Water Valve.</p>
--	--

<p>Universal Base: Fits Both 4 x 6 1/2 & 2 3/4 x 6 1/2 No Capacitor Required, 115V/60hz Kit Includes: Relay Overload, 90 Elbow 3/8" & 5/16" Piercing Valve 1/4" & 5/16" & 20 Gram Heavy Duty Drier.</p> <table border="0"> <tr> <td>12000005</td> <td>1131 BTU, 305W</td> <td>FF 11.5 BKW. ADAPTER FOR 7X7, OIL COOLER</td> </tr> <tr> <td>12000020</td> <td>826BTU, 222W</td> <td>FF 8.5 BKW. ADAPTER FOR 7X7", OIL COOLER</td> </tr> <tr> <td>12000007</td> <td>655 BTU, 173W</td> <td>FF 6 BKW ADAPTER</td> </tr> <tr> <td>12000019</td> <td>516 BTU, 170W</td> <td>PW 5.5 K14W, OIL COOLER</td> </tr> <tr> <td>12000018</td> <td>391 BTU, 125W</td> <td>PW 4.5K11</td> </tr> </table> <p>For R134A Compressors</p> <table border="0"> <tr> <td>12001379</td> <td>825 BTU, 1/4 HP</td> </tr> <tr> <td>12001593</td> <td>1020 BTU, 1/4 HP</td> </tr> <tr> <td>12001591</td> <td>700 BTU, 1/4 HP</td> </tr> <tr> <td>12001592</td> <td>825 BTU, 1/4 HP</td> </tr> </table> 	12000005	1131 BTU, 305W	FF 11.5 BKW. ADAPTER FOR 7X7, OIL COOLER	12000020	826BTU, 222W	FF 8.5 BKW. ADAPTER FOR 7X7", OIL COOLER	12000007	655 BTU, 173W	FF 6 BKW ADAPTER	12000019	516 BTU, 170W	PW 5.5 K14W, OIL COOLER	12000018	391 BTU, 125W	PW 4.5K11	12001379	825 BTU, 1/4 HP	12001593	1020 BTU, 1/4 HP	12001591	700 BTU, 1/4 HP	12001592	825 BTU, 1/4 HP	 <p>13900-1 Service Drier.</p>
12000005	1131 BTU, 305W	FF 11.5 BKW. ADAPTER FOR 7X7, OIL COOLER																						
12000020	826BTU, 222W	FF 8.5 BKW. ADAPTER FOR 7X7", OIL COOLER																						
12000007	655 BTU, 173W	FF 6 BKW ADAPTER																						
12000019	516 BTU, 170W	PW 5.5 K14W, OIL COOLER																						
12000018	391 BTU, 125W	PW 4.5K11																						
12001379	825 BTU, 1/4 HP																							
12001593	1020 BTU, 1/4 HP																							
12001591	700 BTU, 1/4 HP																							
12001592	825 BTU, 1/4 HP																							

Part numbers and illustrations intended solely for identification. Items offered for sale not represented to be manufactured by the company that built the item.

**WE ARE
APPLIANCE
PARTS
Specialists**

**Need A Part?
Give Us A
Call!**



12001771
Admiral Crisper Support.

65246-1
Admiral Shelf Endcap.

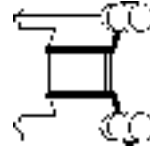

65245-1
Admiral End Cap for Shelves.

- 67213-2 White, 1-1/2"
 - 67213-1 Brown, 1-1/2"
 - 67208-3 White, 2-1/4"
 - 67208-1 Brown, 2-1/4"
 - 67208-2 Brown, 2-3/4"
 - 67211-1 White, 2-5/8"
 - 67211-2 Brown, 2-5/8"
- Admiral Shelf Endcap.

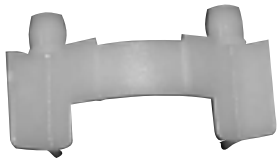

70197-1
Admiral Shelf Endcap.



60100-1
Admiral Kickplate Clip
Screw Mount. 2 Req.
69940-1
Admiral Kickplate Clip
Spring Mount. 2 Req.



67764-1
Admiral Crisper Support.

*Sorry - No images
available at time of
printing*

12001813
Admiral Rack off bin extension
kit.



69871-5
Admiral Pick Offrack.

**Apco's Most Common
Admiral/MAYTAG**

DOOR GASKETS - REFRIGERATOR

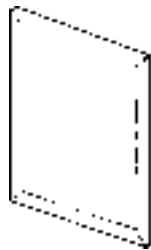

- 70048-1 28 x 36 for 15 Cu. Ft
- 68543-2 28 x 39 for 17 Cu. Ft
- 70048-3 30 x 39 for 19-21 Cu. Ft
- 70048-4 32 x 39 for 23-24 Cu. Ft.
- 70048-2 28 x 39 for 17 Cu. Ft.

**Apco's Most Common
Admiral/MAYTAG**

DOOR GASKETS - FREEZER

- 70047-1 28 x 16 for 15 Cu. Ft
- 68542-2 28 x 18 for 17 Cu. Ft
- 70047-3 30 x 19 for 19-21 Cu. Ft
- 70047-4 32 x 19 for 23-24 Cu. Ft.
- 70047-2 28 x 18 for 17 Cu. Ft.

*Sorry - No images
available at time of
printing*

RA95113-1
Admiral Inner Liner.

12001662
Admiral Repair sticks.

**GUARANTEED
PARTS
PRICE
SERVICE**

**13 LOCATIONS
TO SERVE YOU!**

Tempe . Peoria . North Phoenix
Mesa . Scottsdale . South Tucson
North Tucson . East Tucson
Las Vegas . Reno . Salt Lake City .
San Antonio (2 locations)

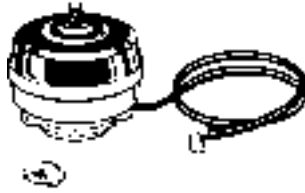

12001314 (67560-8)
Admiral Condenser Motor.

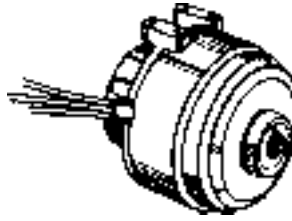

54503-2
Admiral Condenser Motor.



69958-1 (62934-2)
Admiral Condenser Motor
Fan Blade.

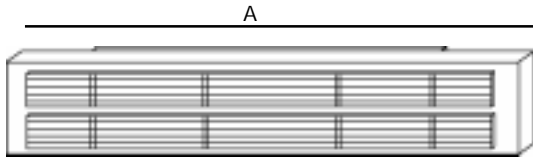

70128-1 A = 27 3/4" Wide
Maytag/Admiral Black Kickplate
with Mounting Clips.
60237-37 A = 28 1/2" Wide
Maytag/Admiral Black Kickplate
Requires 2 - (60100-1) Mounting Clip.
60237-30
Maytag/Admiral Kickplate.
60237-38
Maytag/Admiral Kickplate.

Notes



52854-1
Admiral Refrigerator
Kickplate Clip.



52854-3
Admiral Kickplate Clip.



63084-1
Admiral Hub.



68236-1
Admiral Condenser Pan.
Hangs from side rail &
rests on compressor.

Store Locations

Tempe, AZ	(480) 755-0005
Peoria, AZ	(623) 972-5022
N. Phoenix	(602) 863-3476
Scottsdale, AZ	(480) 970-1010
Mesa, AZ	(480) 827 0161
S. Tucson, AZ	(520) 624-2102
E. Tucson, AZ	(520) 751-8800
N.W. Tucson, AZ	(520) 293-8888
Las Vegas, NV	(702) 382-6532
Reno, NV	(775) 348-9090
Salt Lake City, UT	(801) 975-1333
San Antonio, TX	(210) 223-2675
San Antonio, TX	(210) 525-0636

Part numbers and illustrations intended solely for identification. Items offered for sale not represented to be manufactured by the company that built the item.



54482-10
Admiral Evap. Motor
CCW, 3/16".



56488-2
Admiral Evap. Motor, CW.



69106-2
Admiral Evaporator Motor.

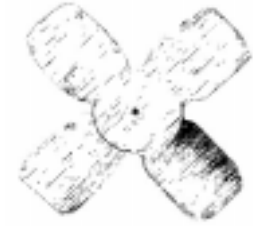

69107-1
Admiral Evaporator Motor
Blade. 4-7/16".

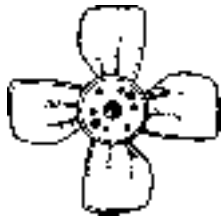

64359-1
Admiral Fan CCW
4 3/8 used with 54482-10.

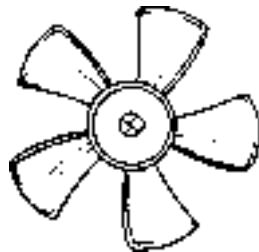

52120-3
Admiral Fan Blade, 4-3/8".

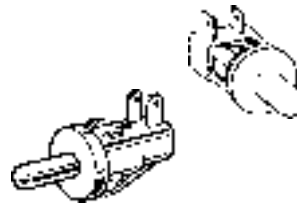

68916-1
Admiral Fan Switch.



66987-1
Light Switch.



31956
Bulb 40 Watt.



69417-7
Admiral Knob for Cold Control.
Clear with Blue Trim.



61002085
W/Temperature stabilizer
61002087
61002088 (61005629)
Admiral Cold Controls.
Later Model.



61005254 L 54°
61002992 L 38°
Admiral Defrost Limit
Thermostat.



61003119
61003120
Admiral Defrost Limit
Thermostat.
43° Limit with Resistor.



61003311
Admiral Yoke/Swivel Strike Piece.



61003507
Admiral Ice Door with Seal.



95109-1
Admiral Control Module.













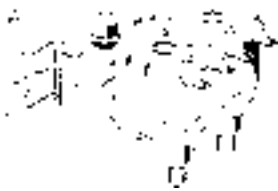

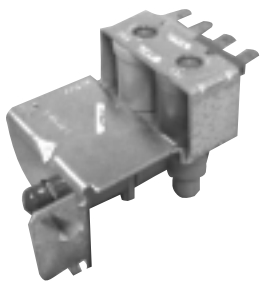

Notes

ADMIRAL REFRIGERATOR











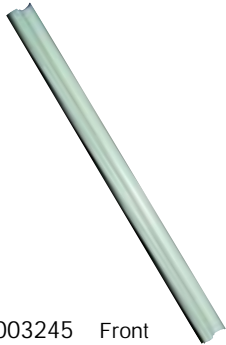

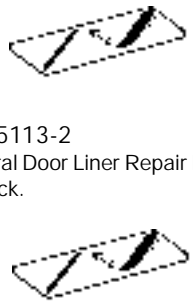
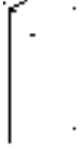
ICEMAKER AND BUCKET PARTS

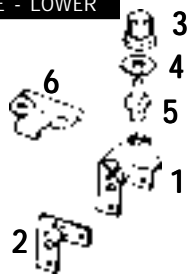
MAYTAG

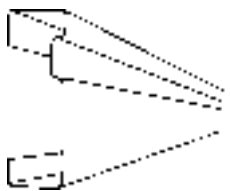
MAYTAG

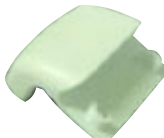
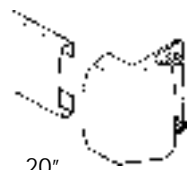
 <p>18001006 (BP314) Installation Plastic Kit 25'. 18001005 (BP313) Installation Copper Kit 25'.</p>	 <p>12001415 New Style Single Valve.</p>	 <p>12001414 New Style Double Valve.</p>	 <p>61001884 Admiral Single Outlet Valve. S/A 12001415 Kit.</p>
 <p>61003317 Admiral Double Outlet Valve. S/A 12001414 Kit.</p>	 <p>58461-3 Admiral Plastic Inlet Tube.</p>	 <p>18001001 18001009 18001010 Maytag Water Filter. Comes With Copper Connections.</p>	 <p>61004737 Admiral Water Filter Kit.</p>
 <p>61003791 Admiral Filter Plug, Bypass.</p>	 <p>61003121 Admiral Ice Door Solenoid with Armature.</p>	 <p>66435-1 Admiral Auger.</p>	 <p>UKF7001AXX UKF7002AXX UKF6001AXX UKF5001AXX Admiral Built-In "Puriclean" Filters.</p>
 <p>63071-1 Admiral Auger Pin.</p>	 <p>70027-2 Admiral Auger Drive Ring.</p>	 <p>66447-1 Admiral Auger Bin.</p>	 <p>66448-1 Admiral White Plastic Impeller.</p>

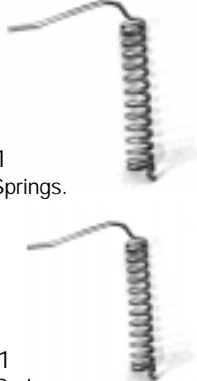
Part numbers and illustrations intended solely for identification. Items offered for sale not represented to be manufactured by the company that built the item.

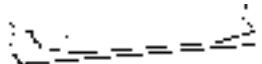
 <p>61003246 Frame 61003247 Glass Admiral Tempered Glass Shelf. 16 1/4" Wide x 18" Deep.</p>	 <p>61003245 Front 61003244 Rear Admiral Tempered Glass Trim.</p>	 <p>70111-16 22" 70111-108 22 3/4" Admiral Door Bar.</p>	 <p>RA95113-2 Admiral Door Liner Repair Kit 50 pack.</p> <p>95065-1 Admiral Repair Kit For Inner Door Panel.</p>
 <p>69168-4 White 69168-5 Almond Admiral Plastic Handle.</p>  <p>049406-01 (56686-2) Black 56686-5 White Admiral Gasket Rivets.</p>	<p>DOOR HINGE - LOWER</p>  <p>1. RA43997-1 Hinge 2. 60165-2 Shim 3. 66036-1 Bushing 4. 54233-1 Washer 5. 53672-1 Pivot Pin 6. 60419-1 Door Stop</p>	<p>DOOR HINGE - CENTER</p>  <p>1. 60031-4 Hinge 2. 60034-1 Shim 3. 60035-4 Pin 4. 52185-1 Spacer 5. 66036-1 Bushing 6. 60326-1 N.L.A 7. 60030-4 Door Stop</p>	<p>DOOR HINGE - UPPER</p>  <p>1. 53079-28 Hinge 2. 66036-1 Bushing 3. 65031-2 Shim 4. 52185-1 Spacer Washer</p>
 <p>61003045 27 3/4" Long 65151-93 22" Long 65151-111 22 3/4" Long Admiral Popular Door Bars.</p>	<p>We list more shelf parts on Page 66!</p>  <p>55556-1 Admiral Door End Cap for Shelves.</p>	 <p>61002112 Admiral Side Latch Endcap. White.</p>  <p>61001963 20" 61001965 21" Admiral Side Latch Door Bar.</p>	 <p>54485-2 Admiral Door Closure.</p>
 <p>56572-1 Admiral Springs.</p> <p>56571-1 Admiral Springs.</p>	 <p>66034-1 Admiral Hinge Bushing Pin.</p>	 <p>61001672 Admiral Support Glide Rail 13" Long. Replaces 68805-1, 68805-2.</p>	 <p>66813-2 Left 66814-2 Right Admiral Meat Tray Rails.</p>